

4.7 ION BEAM PULSING OPTIONS cont.

4.7.2 CAPACITIVE BEAM PULSING WITH PULSE JUNCTION BOX

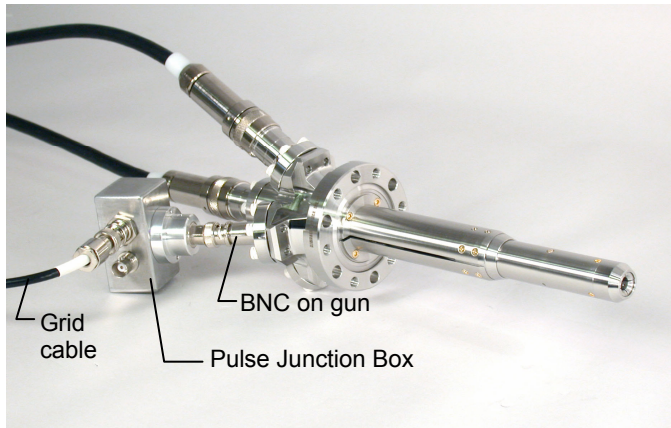

Fig. 4.7-2 A typical alkali metal Ion Gun with Pulse Junction Box attached to Grid BNC

The capacitive pulsing option, also referred to as fast beam pulsing, involves a capacitor-containing device, the Pulse Junction Box, that is attached to the grid BNC on the ion gun. A separate, user-supplied pulse generator capable of producing appropriate voltages (equal to the Grid cut off value) is also required. In the Pulse Junction Box, the voltage outputs from the grid power supply and pulse generator are combined to produce the voltage at the grid in the gun to pulse the beam off and on.

Capacitive pulsing can provide the fastest rise/ fall time and shortest pulse length of the various pulsing methods. However, the capacitor does not permit long pulses or DC operation. If there is a separate grid lead on the gun, this capacitive pulsing option can be added to most low energy gun systems without modification.

PULSE JUNCTION BOX: INSTALLATION

1. A factory installed Grid lead with a BNC on the ion gun, a Pulse Junction Box, and a separate, user-supplied pulse generator are required for installation.
2. See Fig. 4.7-4 below for a diagram of equipment layout. Also refer to the power supply and ion gun installation procedures in Sections 2.2 and 2.3.
3. Connect the Pulse Junction Box as shown in Fig. 4.7-2 and Fig. 4.7-3.
 - a. Connect the output of the Pulse Junction Box directly to the BNC on the ion gun.
 - b. Using the Grid coaxial cable, connect the Grid High Voltage input BNC on the Pulse Junction Box to the IGPS Power Supply BNC labeled **GRID** or **G-1**.
 - c. Using a user-supplied coaxial cable, connect the pulse input BNC (the shorter BNC) on the Pulse Junction Box to the output of the user-supplied pulse generator.
4. Optional: Set up a user-supplied oscilloscope or other equipment to monitor pulsing; a terminating resistor may be needed. (Fig. 4.7-4)

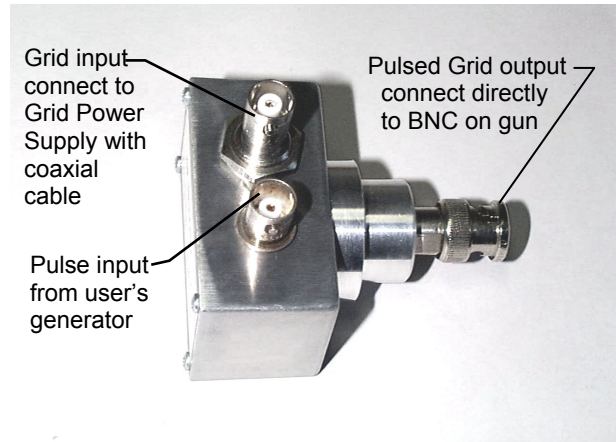

Fig. 4.7-3 Pulse Junction Box, showing connections

POWER INPUT CAUTIONS

The maximum average power recommended for the standard Pulse Junction Box is 1 WATT. The circuitry in the box includes a 50 Ω resistor for termination to ground. The power input from the user's pulse generator must be kept low enough so that the resistor will not be damaged.

The power input can be calculated using the following equation:

$$V^2 / R = P \text{ (the total DC power).}$$

For example, if 100 V from the user's pulse generator is applied to pulse the beam, 100 V squared divided by the 50 Ω resistor equals 200 Watts continuous DC power, which would quickly destroy the circuitry in the box.

With pulsing, the overall power input is reduced, as calculated by the following equations:

Pulse width (duration of pulse) \times **frequency** = **duty cycle** (fraction of time the beam is on) and

Duty cycle \times **total P** = **Avg pulsed Power.**

For example, with a 5 μ sec pulse at 1 kHz, the time on is 5×10^{-6} sec multiplied by 10^3 cycles/sec which equals 0.005 or a 0.5% duty cycle. Thus the average pulsed power with a 100 V input would be 0.005 times the 200 W which equals 1 Watt, the limit of what is considered safe for the Pulse Junction Box. Either a higher voltage input or longer pulses or a higher frequency could damage the circuitry.

Thus, before operating, it is important to calculate the expected pulsed power input. This is not generally a concern with low energy, low current guns such as the ILG-6 which can be cut off with a low grid voltage. However, it may be a problem with higher energy, or higher current guns, which requires a higher grid voltages for cut off. There can also be a problem with very long pulses; the Pulse Junction Box is designed for fast pulsing. Pulse widths from 20 ns to 100 μ s can be achieved with appropriated inputs. Some examples of allowable pulsing parameters are given in Table 4.7-1 on the next page.

4.7 ION BEAM PULSING OPTIONS cont.

CAPACITIVE BEAM PULSING with PULSE JUNCTION BOX cont.

CAUTION

DO NOT EXCEED 1 WATTS AVERAGE INPUT
due to 50 Ω input impedance.

Do not use ECC mode when pulsing.
The ECC feedback may raise the source heater temperature and reduce ion source lifetime.

The input BNC on the Pulse Junction Box must **NOT** be grounded, even when not in use.

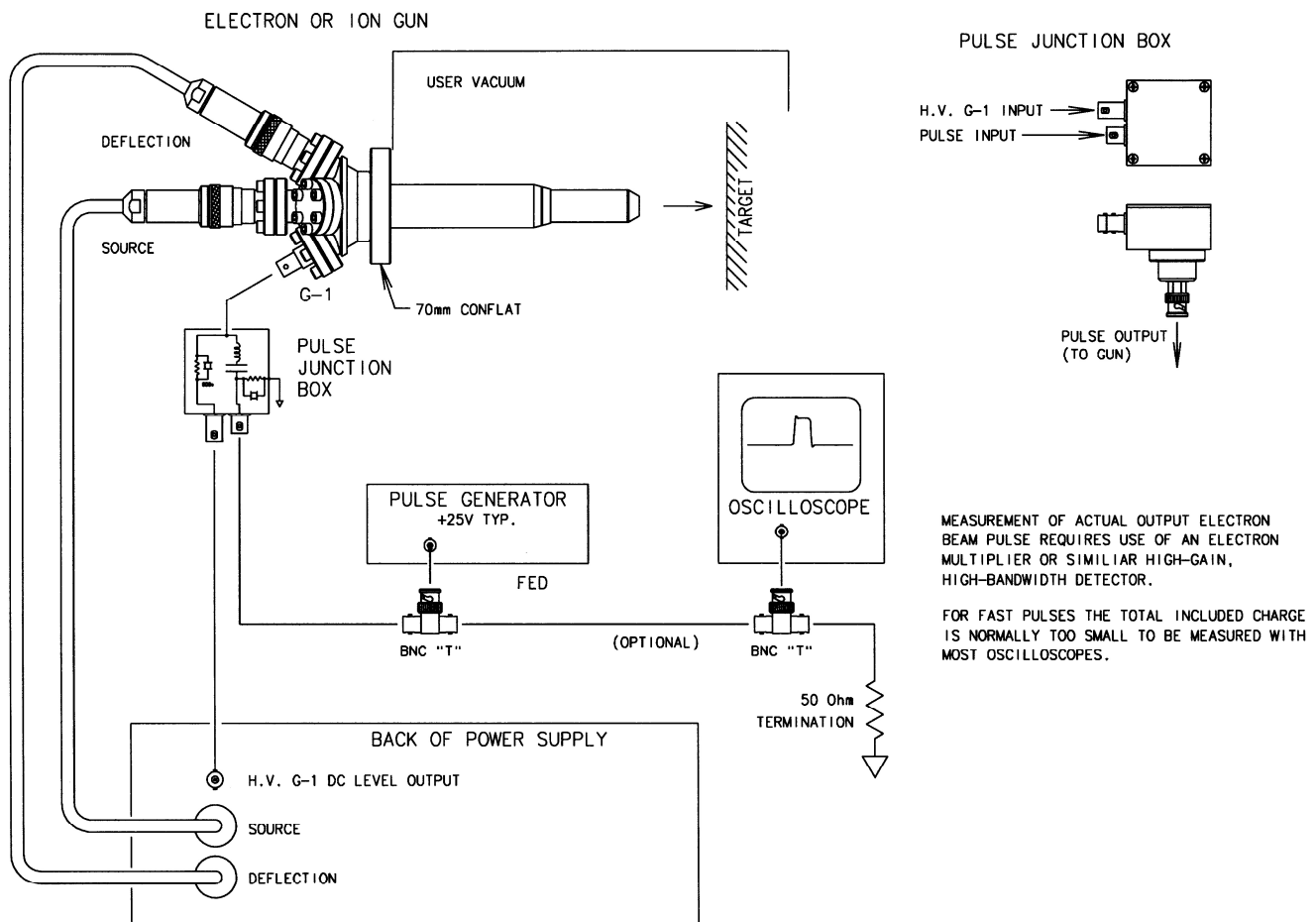

Fig. 4.7-4 Pulse Junction Box connections to gun, power supply and user-supplied equipment

Table 4.7-1 Pulse Input Limits for Standard Pulse Junction Box

Pulse Voltage Input (depends on gun model)	Pulse Width	Pulse Frequency (Repetition Rate)	Average Power (calculated)
25 V	20 ns	4 MHz	1 W
	100 μs	800 Hz	
100 V	20 ns	250 kHz	
	100 μs	50 Hz	
500 V	20 ns	10 kHz	
	100 μs	2 Hz	

4.7 ION BEAM PULSING OPTIONS cont.

PULSE JUNCTION BOX: DESCRIPTION of GRID PULSING VOLTAGES and BEAM RESPONSE

Pulsing of the beam current is accomplished by sending a pulse through a capacitor to the control grid aperture. The general pattern of the beam pulsing is a square wave with a variable width (time off and time on) and a variable repetition rate. A pulse width from 20 nsec to 100 μ sec can be created with an appropriate pulse generator.

The grid voltage is positive with respect to the ion source. To pulse the gun on, negative voltage pulses are required. The grid voltage on the IGPS Power Supply should be turned up so that the ion beam is cut off. Data is supplied in the Data Section showing the grid cutoff values for the gun. By sending a pulse of the appropriate amplitude through the Pulse Junction Box, the gun will be turned on for the duration of the pulse.

A capacitor in the Pulse Junction Box isolates the high voltage from the low voltage pulse generator. The pulse is transmitted from a ground-referenced pulse generator, through this capacitor to the control grid which is floating at the high voltage of the Energy supply.

The figure below illustrates the beam current response in fast beam pulsing. The grid power supply and pulse generator outputs superimpose to produce the voltage applied to the grid aperture. This grid voltage then controls the beam current.

For example, a grid cut off voltage of +40 V plus a negative pulse of -30 V yields a pulse of +10 V on the grid inside the gun. This combined voltage then pulses the beam on. The values shown for illustration purposes are for a typical ion at at mid energy range. The actual values of grid cut off and beam current will vary with the gun model and operating parameters, such as Energy and Extract. (See Data Section).

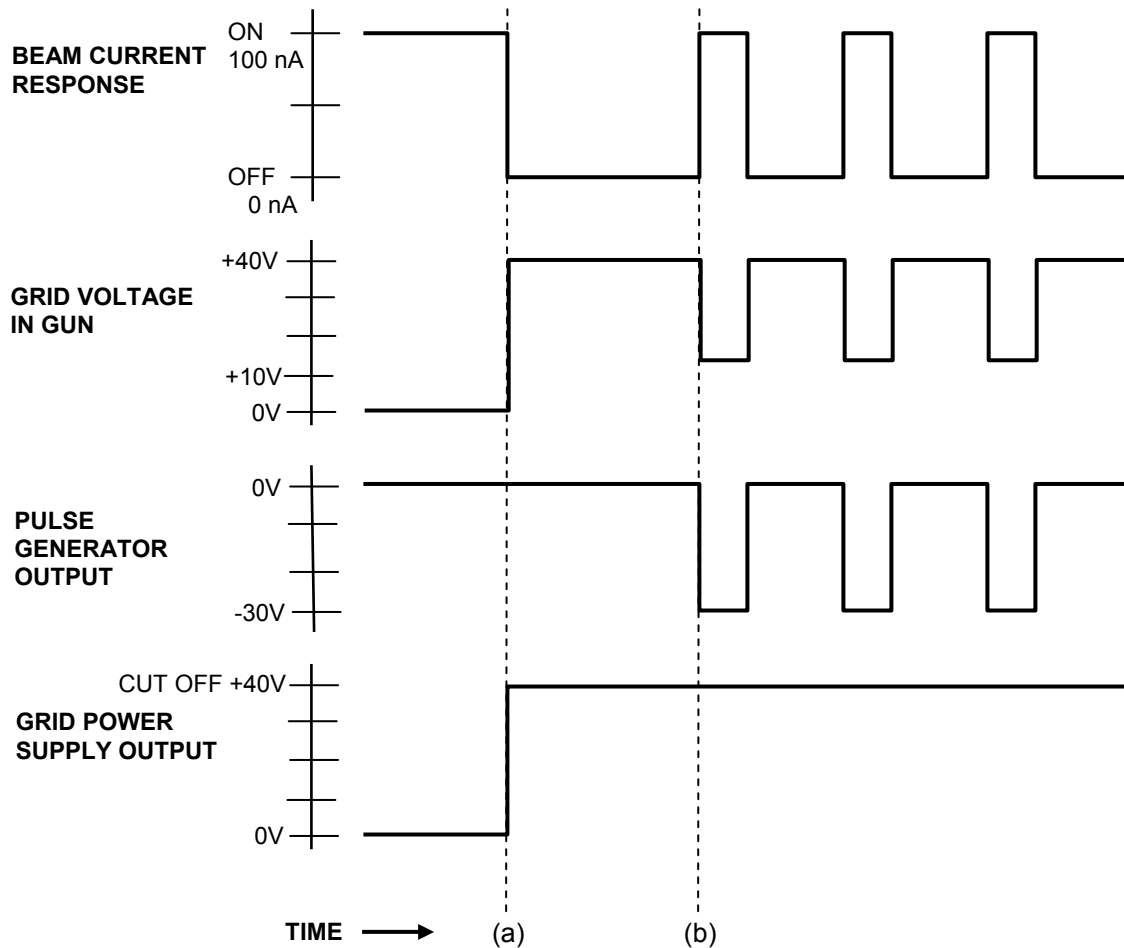



Fig. 4.7-5 Capacitive Fast Beam Pulsing diagram: At time (a) the grid power supply control is set to the cut off voltage, and at time (b) the pulse generator is turned on. (Voltage values depend on the particular gun model and options.)



4.7 ION BEAM PULSING OPTIONS cont.

PULSE JUNCTION BOX: OPERATION

	 CAUTION
	DO NOT EXCEED 1 WATT AVERAGE INPUT due to 50 Ω input impedance.
	Do not use ECC mode when pulsing. The ECC feedback may raise the source heater temperature and reduce ion source lifetime. The input BNC on the Pulse Junction Box must NOT be grounded, even when not in use.

1. Calculate the expected power in the Pulse Junction Box, based on the desired pulse length and frequency and the grid cutoff value for the particular gun. See Power Input Cautions and Table 4.7-1, above.
2. Start up the ion gun in normal Source mode according to Section 4.2.
CAUTION: Do not use ECC mode when pulsing.
If the system also includes a Dual Grid Pulsing option, its input must be set so that the beam is constantly on.
3. On the IGPS, adjust the Grid voltage to the point where it just completely cuts off the ion beam current using the **GRID** control (potentiometer, encoder wheel or computer remote control). The way the voltages control the beam is described above.

4. On the user-supplied pulse generator, set the input pulse:
 - a. Turn on the generator, and set the desired pulse rate.
 - b. Adjust the negative voltage input to the Pulse Junction Box so that the desired pulsed beam current is achieved. **CAUTION: Do not exceed 1 W average power input.**
 - c. Using an oscilloscope, the pulse amplitude and the grid voltage can be fine-tuned to reduce ringing and improve beam output. Note: When monitoring the beam pulse, the input impedance of the oscilloscope may need to be changed by use of a terminating resistor.
5. When not using the pulsing option: Disconnect or turn off the user-supplied pulse generator. The pulse input BNC on the Pulse Junction Box must NOT be grounded even when not in use. If the input BNC is grounded, the grid in the gun will be grounded, and not at the voltage set.
NOTE: The Grid Coaxial Cable must always be connected between the gun and the IGPS Power Supply (with or without the Pulse Junction Box between).

	 WARNING
	HIGH VOLTAGE can cause ELECTRIC SHOCK
	Internal capacitors in the pulse junction box could remain charged. Use caution to avoid shocks. Do not touch terminals immediately after use.

4 OPERATION

This completes the Capacitive Pulsing with the Pulse Junction Box Instructions.