

## 4.8 BEAM PULSING OPTIONS cont.

### 4.8.2 CAPACITIVE BEAM PULSING WITH PULSE JUNCTION CYLINDER

The capacitive pulsing option, also referred to as fast beam pulsing, involves a capacitor-containing device, the Pulse Junction Cylinder, that is attached to the central feedthrough of the electron gun. A separate, user-supplied pulse generator capable of producing appropriate voltages (equal to the Grid cut off value) is also required. In the Pulse Junction Cylinder, the voltage outputs from the grid power supply and pulse generator are combined to produce the voltage at the grid in the gun to pulse the beam off and on.

If there is an appropriate four-pin feedthrough on the gun which includes the grid lead, this capacitive pulsing option can be added to the gun system without modification.

Capacitive pulsing can provide the fastest rise/ fall time and shortest pulse length of the various pulsing methods. However, the capacitor does not permit long pulses or DC operation.

#### POWER INPUT CAUTIONS

**The maximum average power recommended for the high power Pulse Junction Cylinder is 5 WATTS.** The circuitry in the cylinder includes a 1 k $\Omega$  resistor for termination to ground. The power input from the user's pulse generator must be kept low enough so that the resistor will not be damaged.

The power input can be calculated using the following equation:  $V^2 / R = P$  (the total DC power).

For example, if 500 V from the user's pulse generator is applied to pulse the beam, 500 V squared divided by the 1 k $\Omega$  resistor equals 250 Watts continuous DC power, which would quickly destroy the circuitry in the cylinder.

With pulsing, the overall power input is reduced, as calculated by the following equations:

**Pulse width** (duration of pulse) **x frequency** = **duty cycle**  
(fraction of time the beam is on) and

**Duty cycle x total P** = **Avg pulsed Power.**

For example, with a 20  $\mu$ sec pulse at 1 kHz, the time on is  $2 \times 10^{-5}$  sec multiplied by  $10^3$  cycles/sec which equals 0.02 or a 2% duty cycle. Thus the average pulsed power with a 500 V input would be 0.02 times the 250 W which equals 5 Watts, the limit of what is considered safe for the high power Pulse Junction Cylinder. Either a higher voltage input or longer pulses or a higher frequency could damage the circuitry.

Thus, before operating, it is important to calculate the expected pulsed power input. This is not generally a concern with low energy, low current guns which can be cut off with a low grid voltage. However, it may be a problem with higher energy, or higher current guns, which requires a higher grid voltage for cut off. There can also be a problem with very long pulses; the Pulse Junction Cylinder is designed for fast pulsing. Pulse widths from 20 ns to 100  $\mu$ s can be achieved with appropriated inputs. Some examples of allowable pulsing parameters are given in Table 4.8-2 on the next page.

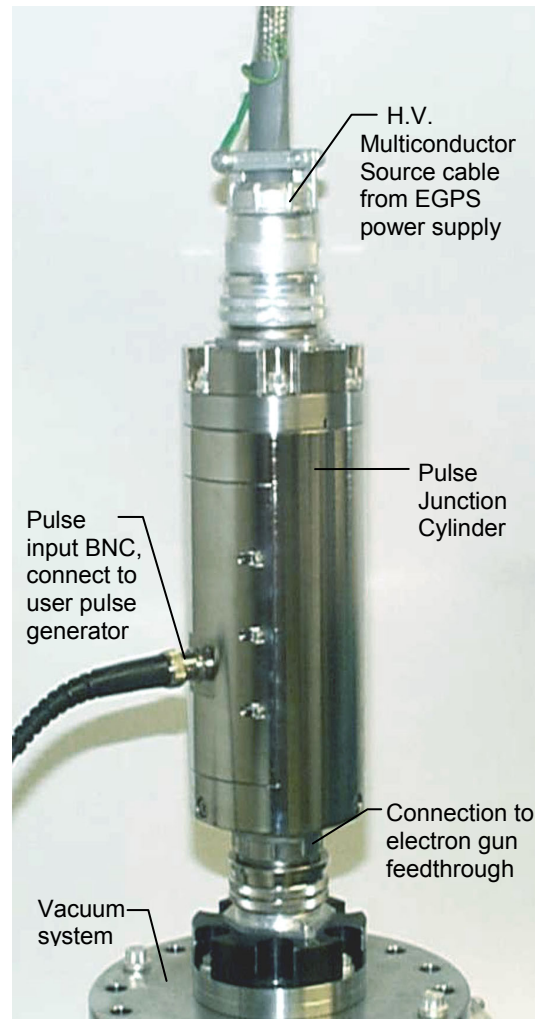





Fig. 4.8-2 Pulse Junction Cylinder, installed on a typical electron gun, showing connections

	<b>CAUTION</b>
	<b>DO NOT EXCEED 5 WATTS AVERAGE INPUT due to 1 k<math>\Omega</math> input impedance.</b>
	<b>Do not use ECC mode when pulsing.</b> The ECC feedback may raise the cathode temperature and reduce cathode lifetime.  The input BNC on the Pulse Junction Cylinder must NOT be grounded, even when not in use.

## 4.8 BEAM PULSING OPTIONS cont.

### PULSE JUNCTION CYLINDER: INSTALLATION

	 <b>CAUTION</b>
	<p><b>Support the Pulse Junction Cylinder</b> so that no force is exerted on the gun feedthrough. Otherwise the ceramic feedthrough may be damaged.</p>

 <b>NOTE</b>
<p>Gun surfaces exposed to vacuum, and high voltage insulator ends on the cables, should not be handled with bare hands. <b>Use clean room gloves</b> to keep parts free of fingerprints and contaminants.</p> <p>The minimum bend radius of the H.V. Source cable is 0.25 meters. <b>Do not twist cables.</b></p>

1. An electron gun with a four pin central feedthrough, a Pulse Junction Cylinder, and a separate, user-supplied, pulse generator capable of producing appropriate voltages (equal to the Grid cut off value) are required for installation.
2. Refer to the power supply and electron gun installation procedures in Sections 2.2 and 2.3. Mount the gun on the vacuum system as described, but do not attach the cables yet.
3. Install the Pulse Junction Cylinder on the 2<sup>3</sup>/<sub>4</sub> CF gun flange, as shown in Fig. 4.8-2. Observe the key when connecting the four pins. **CAUTION: Avoid tilting, twisting or excessive force**, otherwise the ceramic feedthroughs may be damaged.
  - a. **If the electron gun is mounted horizontally, the Pulse Junction Cylinder must be supported**, because the gun feedthrough cannot withstand the weight of the unsupported Pulse Junction Cylinder and cable.
  - b. If the electron gun is mounted vertically, ensure that the Pulse Junction Cylinder and cable are **protected from rocking or bumping**, otherwise feedthrough breakage could occur.
4. Connect the H.V. Multiconductor Source cable to the flange end of the Pulse Junction Cylinder.
  - a. Wipe the short white insulator on the connector with isopropanol and a lint-free cloth.
  - b. Gently insert the 4-pin connector on H.V. Multiconductor Source cable into the central keyed vacuum feedthrough on the Electron Gun, tightening the ring by hand. Observe the key position and avoid excessive twisting or force when inserting cable. It is recommended that the cable be supported along its entire length to prevent the cable from sagging.
  - c. If present, check that the small green grounding wire on the connector is tightly attached.
5. Using a user-supplied coaxial cable, connect the pulse input BNC on the side of the cylinder to the output of a separate user-supplied pulse generator.
6. Complete gun installation, attaching other gun cables as described in Section 2.3.
7. Optional: Set up a user-supplied oscilloscope or other equipment to monitor pulsing; a terminating resistor may be needed.

4 OPERATION

**Table 4.8-2 Pulse Input Limits for High Power Pulse Junction Cylinder**

Pulse Voltage Input (depends on gun model)	Pulse Width	Pulse Frequency (Repetition Rate)	Average Power (calculated)
100 V	20 ns	25 MHz	5 W
	100 μs	5 kHz	
500 V	20 ns	1 MHz	
	100 μs	200 Hz	
1000 V	20 ns	250 kHz	
	100 μs	50 Hz	

## 4.8 BEAM PULSING OPTIONS cont.

### PULSING with PULSE JUNCTION CYLINDER: DESCRIPTION of GRID PULSING VOLTAGES and BEAM RESPONSE

Pulsing of the beam current is accomplished by sending a pulse through a capacitor to the control grid Wehnelt aperture. The general pattern of the beam pulsing is a square wave with a variable width (time off and time on) and a variable repetition rate. A pulse width from 20 nsec to 100  $\mu$ sec can be created with an appropriate pulse generator.

The grid voltage is negative with respect to the cathode. To pulse the gun on, positive voltage pulses are required. The grid voltage on the EGPS Power Supply should be turned up so that the electron beam is cut off. Data is supplied in the Data Section showing the grid cutoff values for the gun. By sending a pulse of the appropriate amplitude through the Pulse Junction Cylinder, the gun will be turned on for the duration of the pulse.

A capacitor in the Pulse Junction Cylinder isolates the high voltage from the low voltage pulse generator. The pulse is transmitted from a ground-referenced pulse generator, through this capacitor to the control grid which is floating at the high voltage of the Energy supply.

The figure below illustrates the beam current response in fast beam pulsing. The grid power supply and pulse generator outputs superimpose to produce the voltage applied to the grid aperture. This grid voltage then controls the beam current.

For example, a grid cut off voltage of -300 V plus a positive pulse of +200 V yields a pulse of -100 V on the grid inside the gun. This combined voltage then pulses the beam on. The values shown for illustration purposes are for a typical EGG-3H Electron Gun at a high energy. The actual values of grid cut off and beam current will vary with the gun model and operating parameters, such as Energy. (See Data Section).

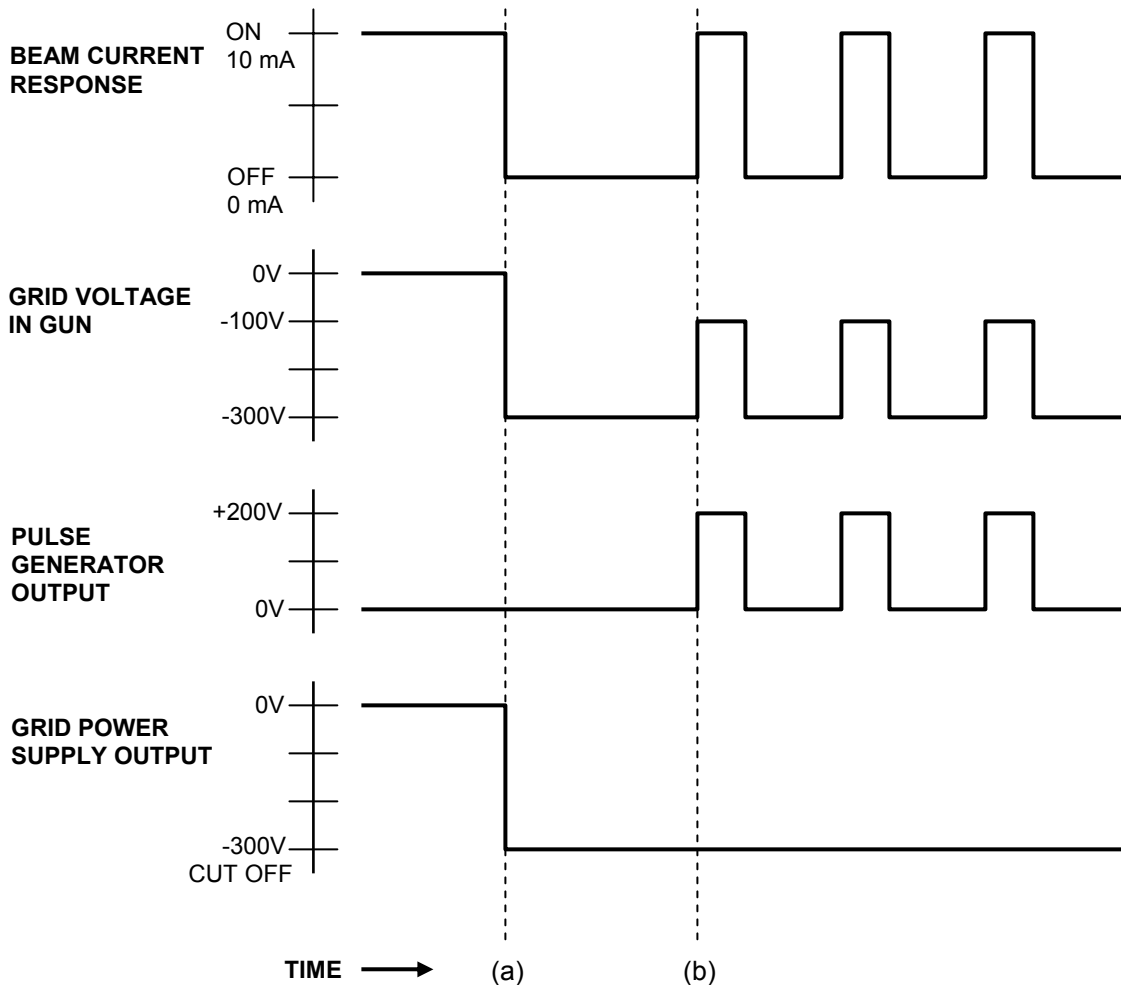



Fig. 4.8-3 Capacitive Fast Beam Pulsing diagram: At time (a) the grid power supply control is set to the cut off voltage, and at time (b) the pulse generator is turned on. (Voltage values depend on the particular gun model and options.)

## 4.8 BEAM PULSING OPTIONS cont.

### PULSING with PULSE JUNCTION CYLINDER: OPERATION

	<b>CAUTION</b>
	<b>DO NOT EXCEED 5 WATTS AVERAGE INPUT due to 1 kΩ input impedance.</b>
	<b>Do not use ECC mode when pulsing.</b> The ECC feedback may raise the cathode temperature and reduce cathode lifetime.  The input BNC on the Pulse Junction Cylinder must NOT be grounded, even when not in use.

1. Calculate the expected power in the Pulse Junction Cylinder, based on the desired pulse length and frequency and the grid cutoff value for the particular gun. See Power Input Cautions and Table 4.8-2, above.
2. Start up the electron gun in normal Source mode according to Section 4.2.  
**CAUTION: Do not use ECC mode when pulsing.**
3. On the EGPS, adjust the Grid voltage to the point where it just completely cuts off the electron beam current using the **GRID** control (potentiometer, encoder wheel or computer remote control). The way the voltages control the beam is described above

4. On the user-supplied pulse generator, set the input pulse:
  - a. Turn on the generator, and set the desired pulse rate.
  - b. Adjust the positive voltage input to the Pulse Junction Cylinder so that the desired pulsed beam current is achieved. **CAUTION: Do not exceed 5 W average power input.**
  - c. Using an oscilloscope, the pulse amplitude and the grid voltage can be fine-tuned to reduce ringing and improve beam output. Note: When monitoring the beam pulse, the input impedance of the oscilloscope may need to be changed by use of a terminating resistor.
5. When not using the pulsing option: Disconnect or turn off the user-supplied pulse generator. The pulse input BNC on the Pulse Junction Cylinder must NOT be grounded even when not in use. If the input BNC is grounded, the grid in the gun will be grounded, and not at the voltage set.

**CAUTION: The input BNC on the Pulse Junction Cylinder must NOT be grounded even when not in use.**

	<b>WARNING</b>
	<b>HIGH VOLTAGE can cause ELECTRIC SHOCK</b>
	Internal capacitors in the pulse junction cylinder could remain charged. Use caution to avoid shocks. Do not touch connectors immediately after use.

4 OPERATION

**This completes the Capacitive Pulsing with the Pulse Junction Cylinder Instructions.**